

MASTERSHIP

Bonito boats project 50ft motor yacht

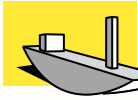

MASTERSHIP

Modulaire ship building



MASTERSHIP

Space Claim

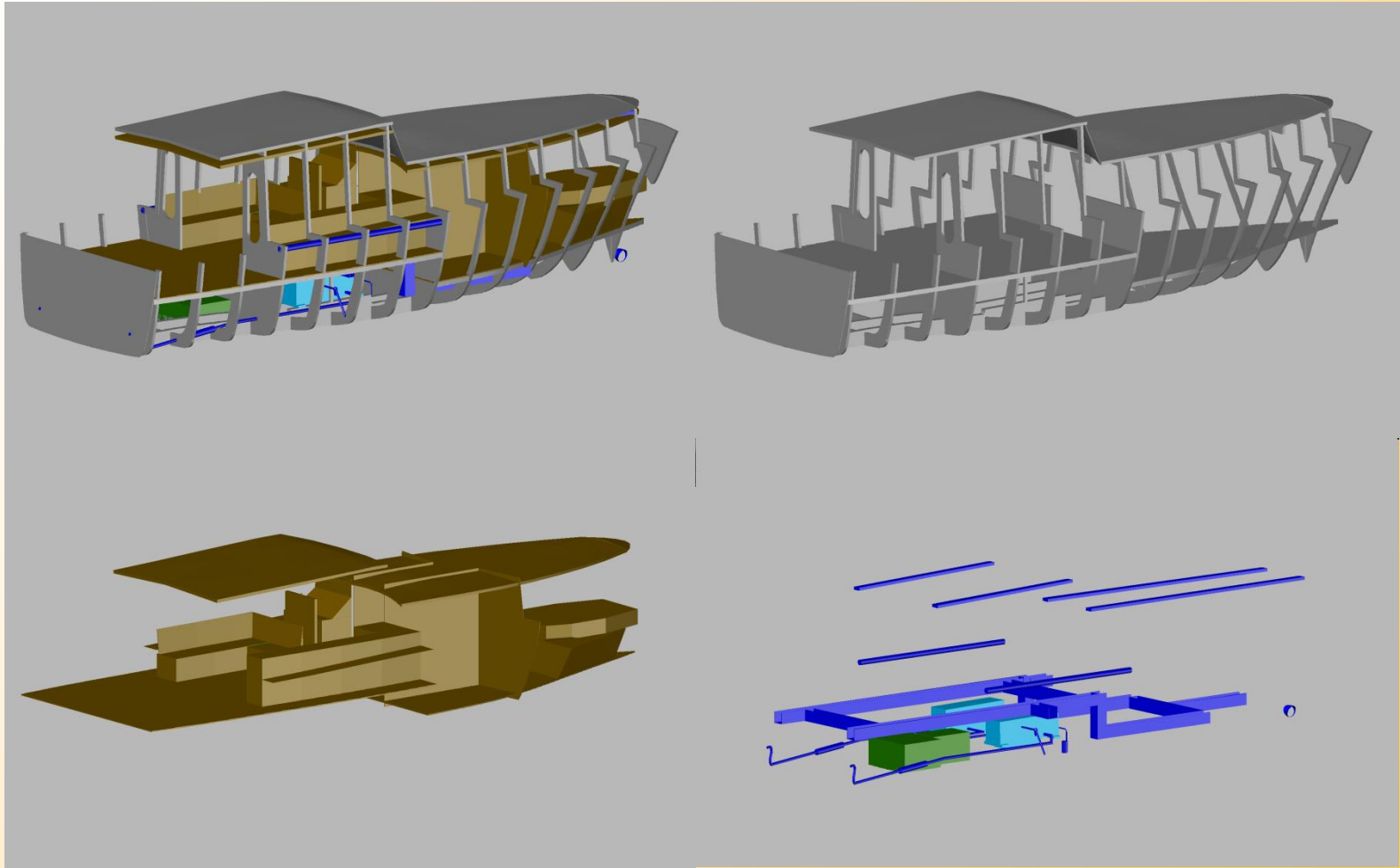

Space claim

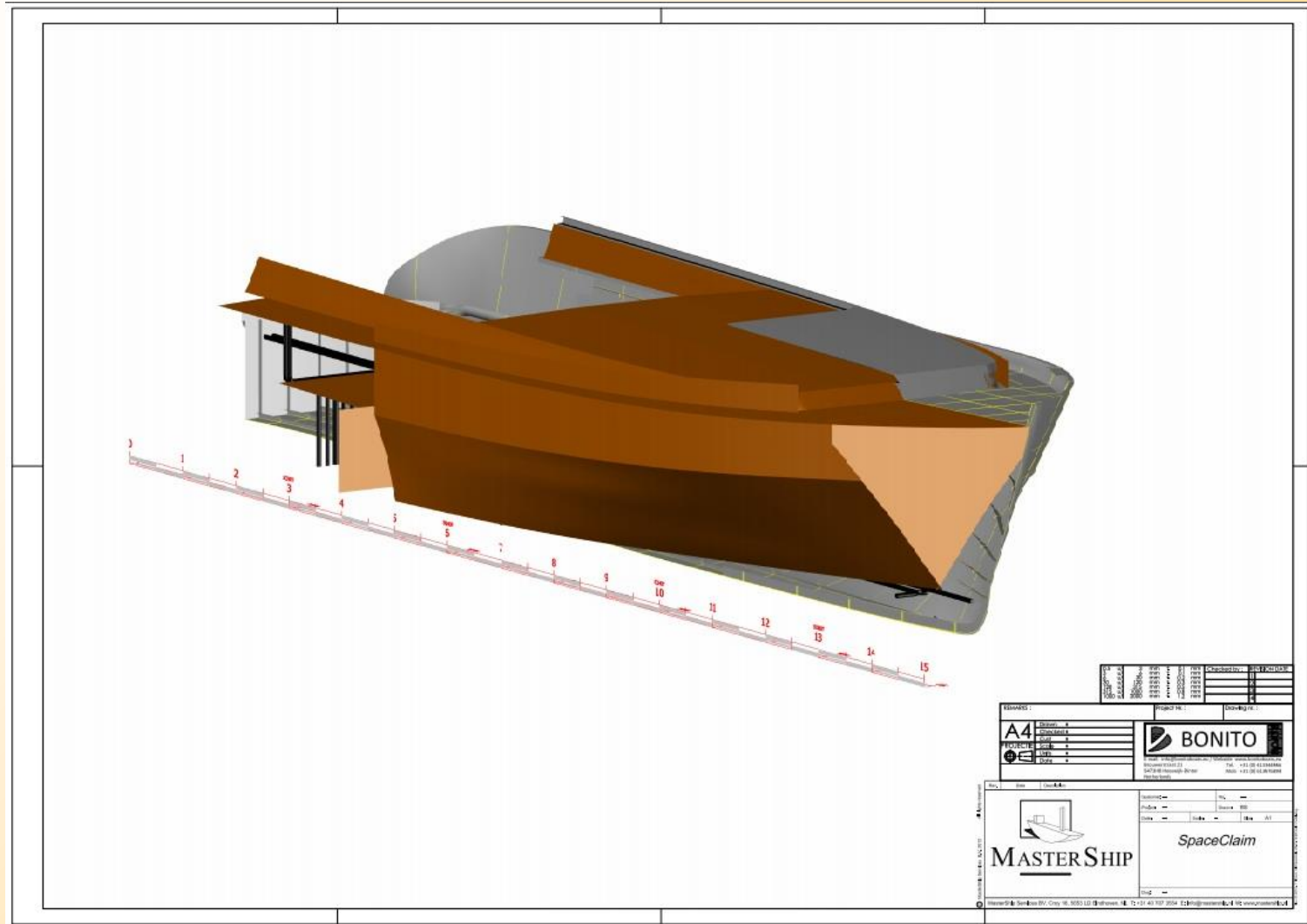

Proof of concept



Proof of concept

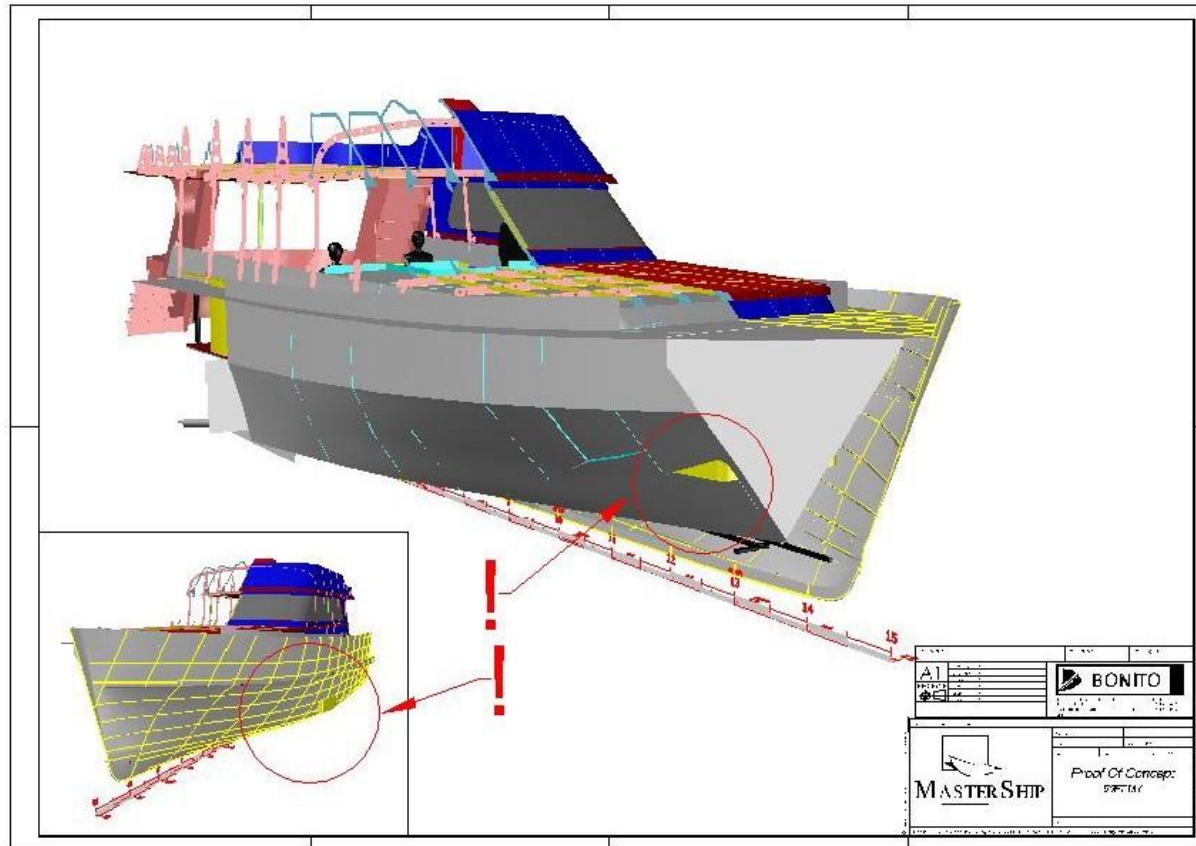



MASTERSHIP

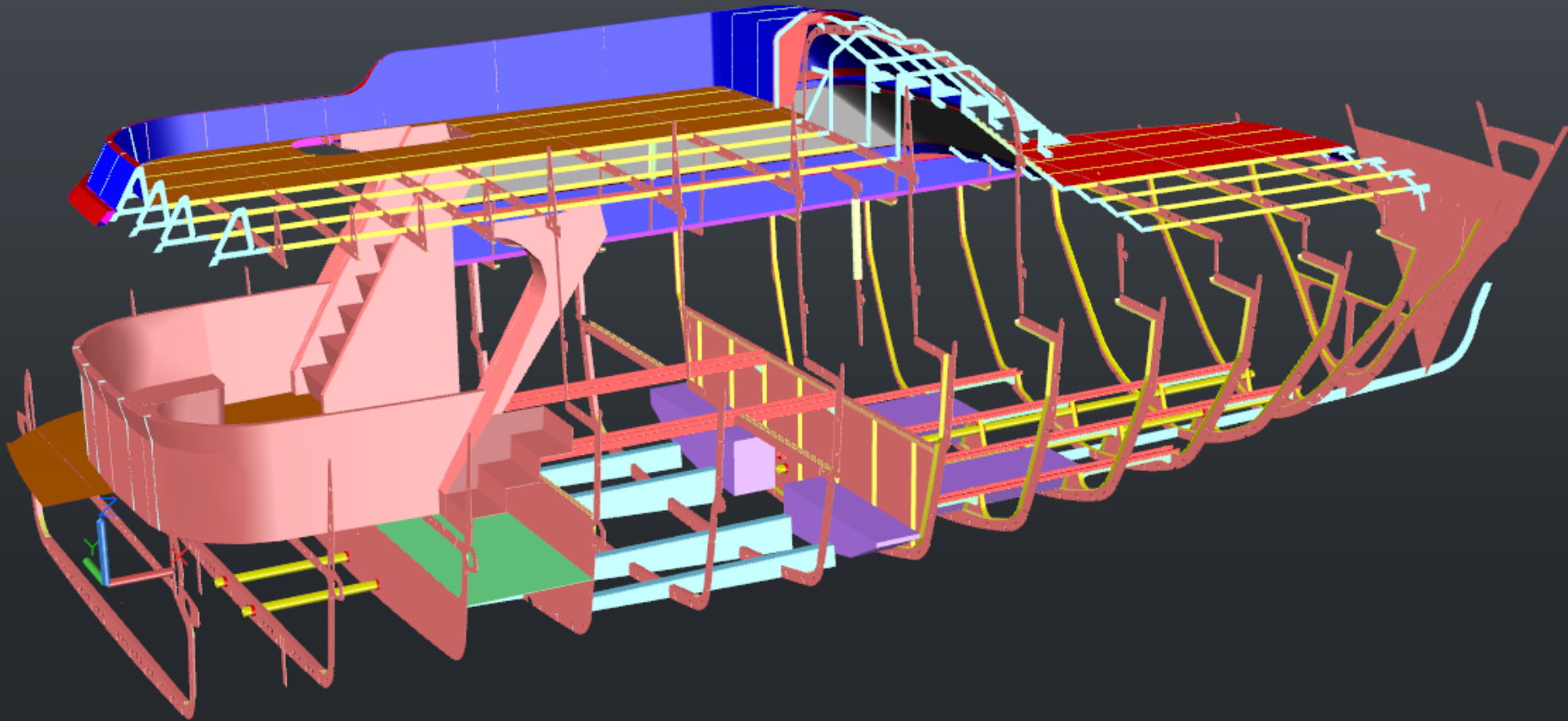

SPECIALISTS IN CAD/CAM SOFTWARE AND ENGINEERING

Basic interior design

(after proof of concept)

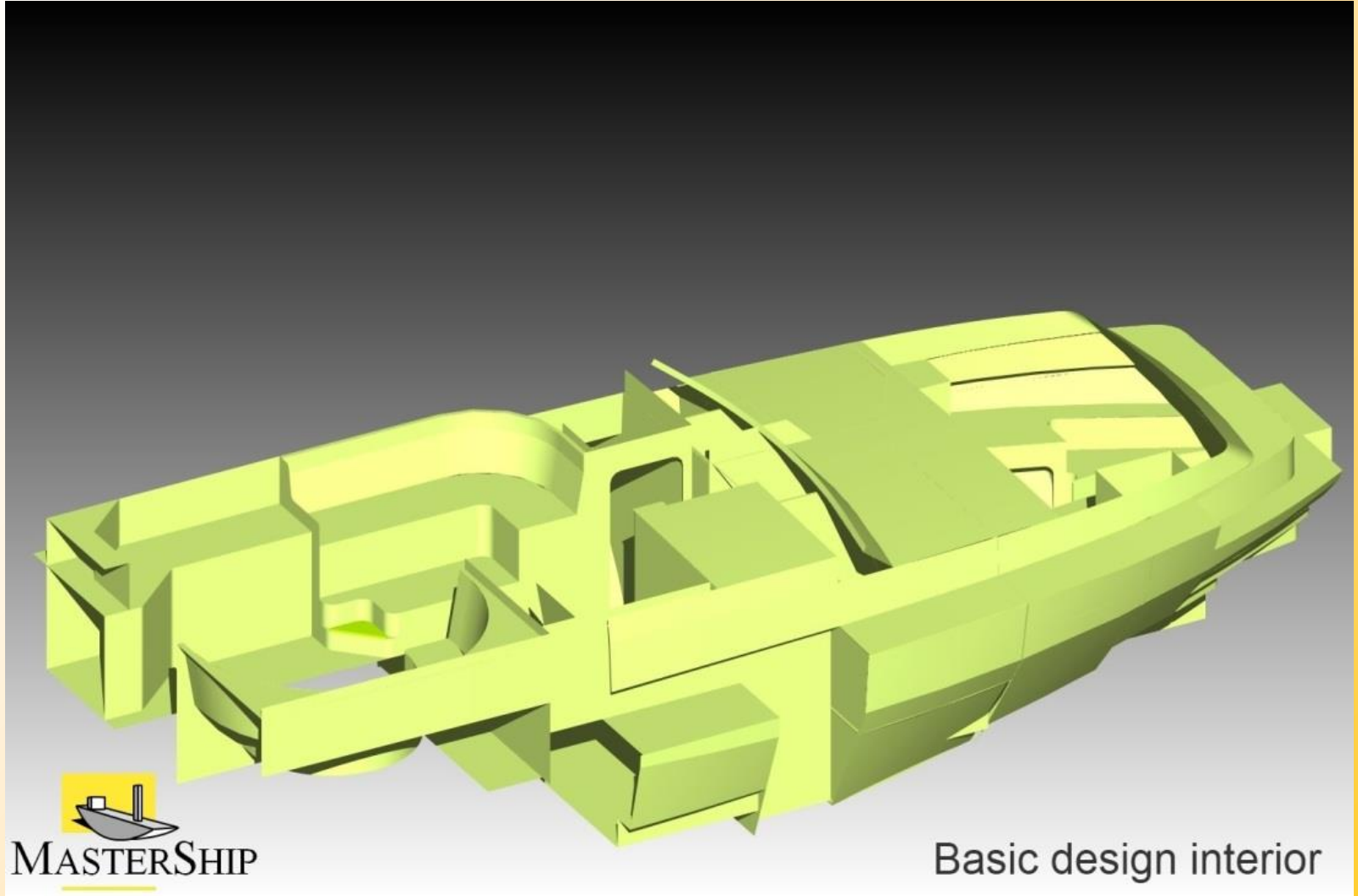

Sketching with pencil and eraser

a bridge between 3D CAD model and human feeling

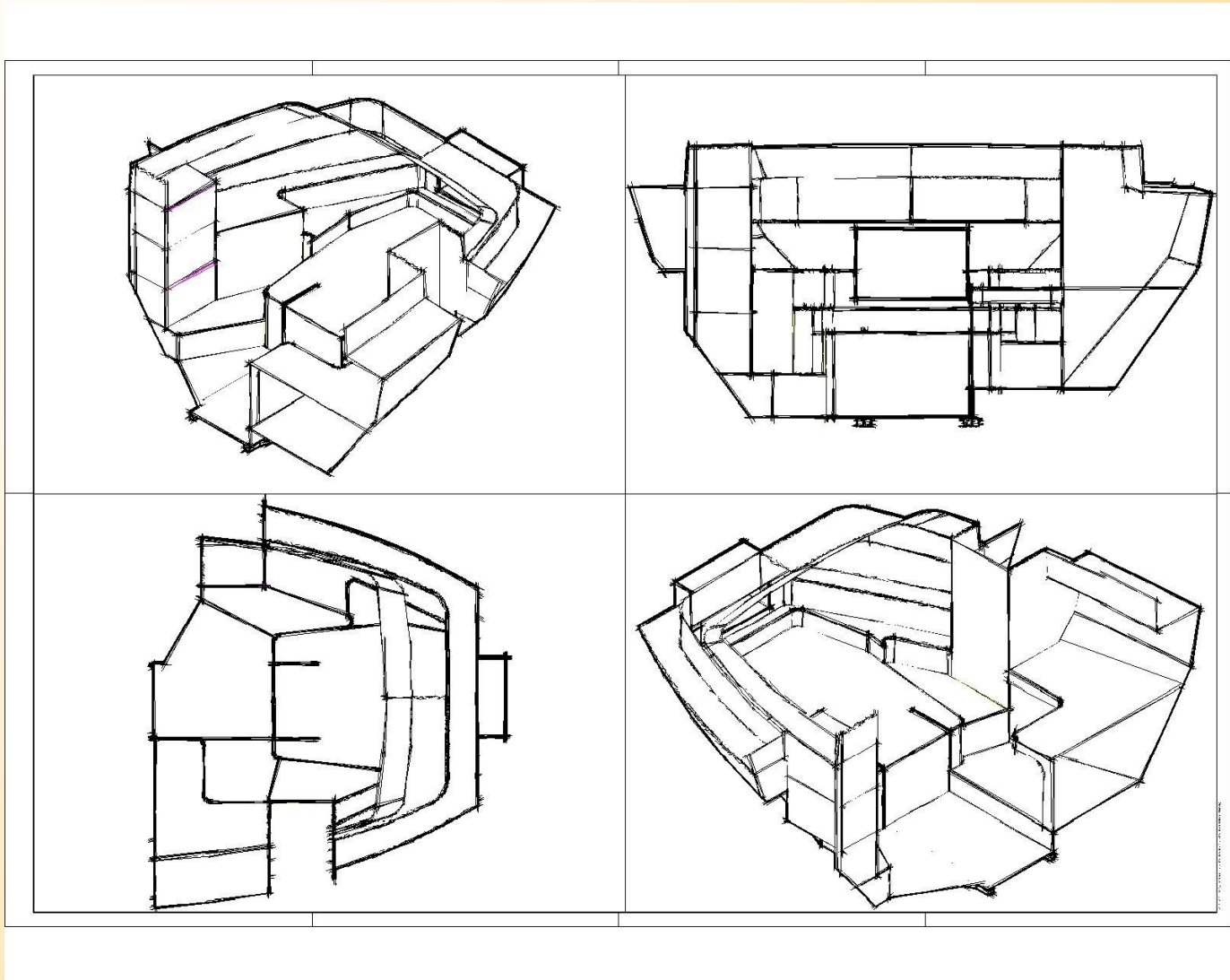

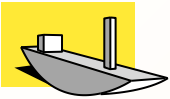

MASTERSHIP

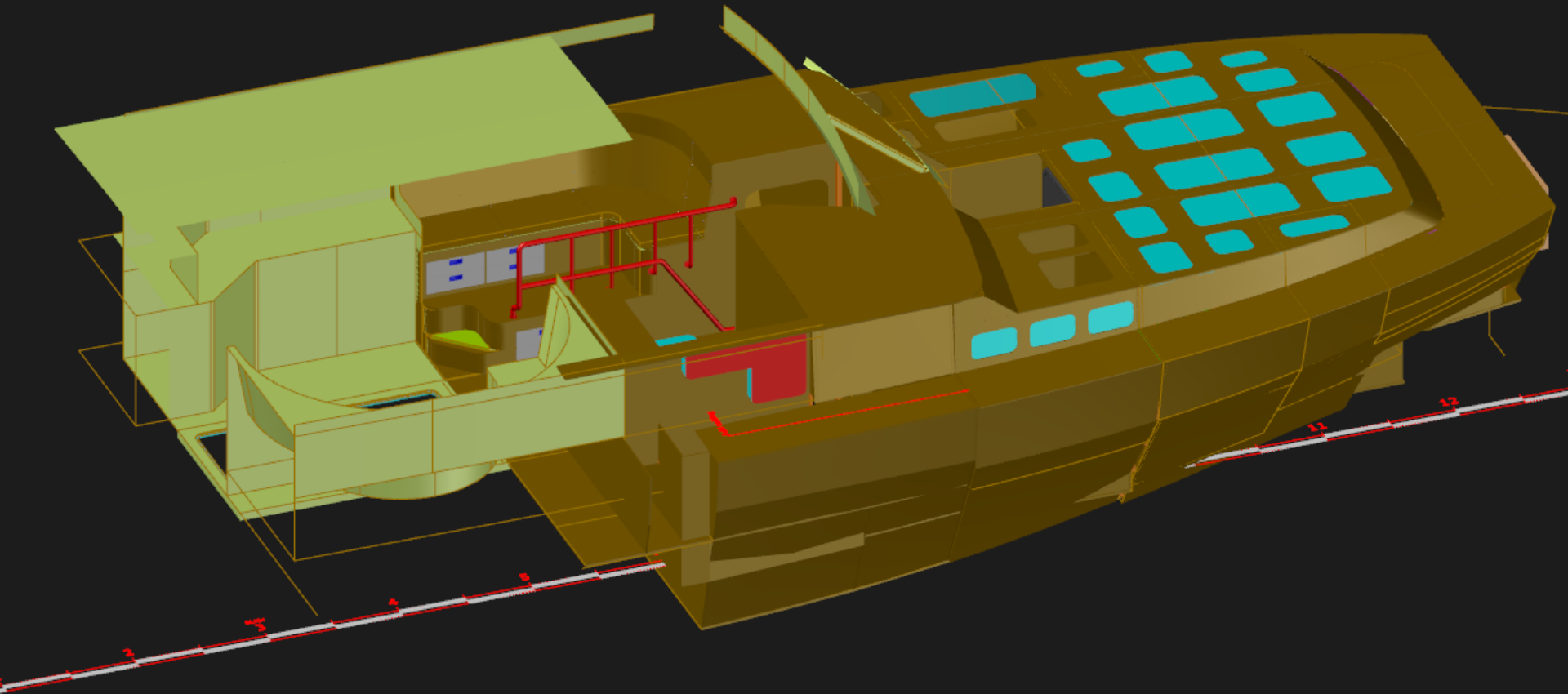

SPECIALISTS IN CAD/CAM SOFTWARE AND ENGINEERING

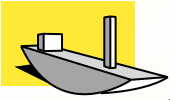

MASTERSHIP

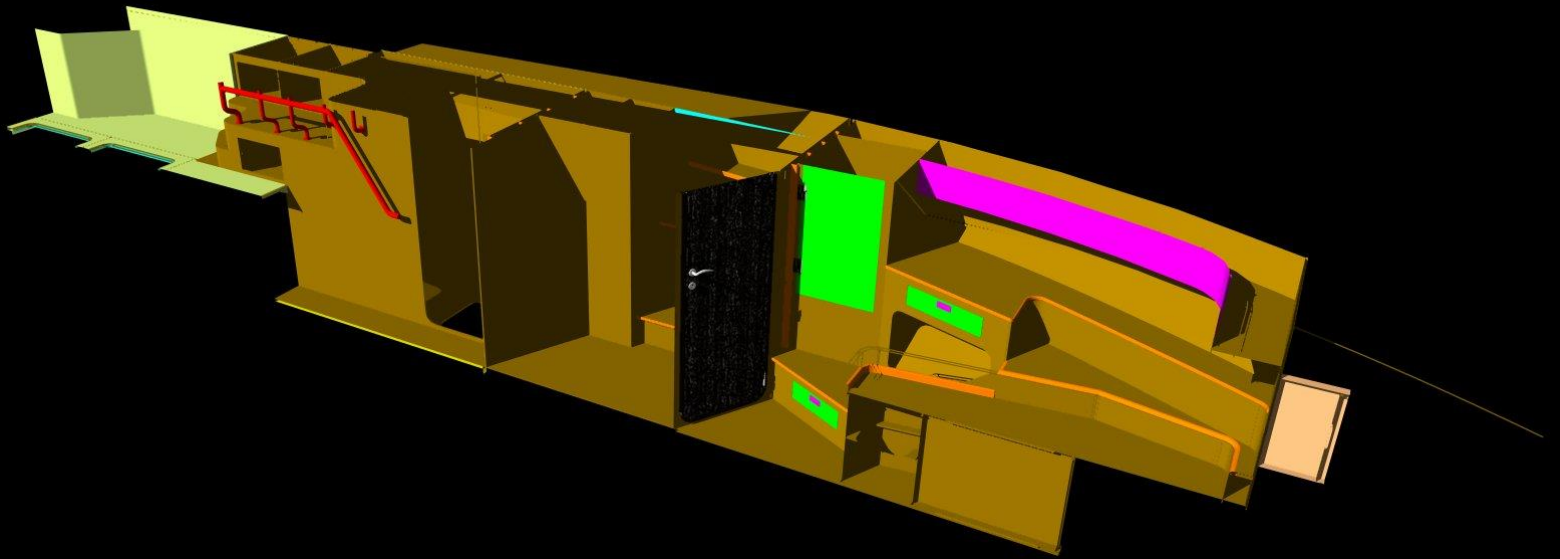

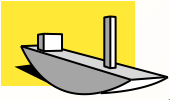

MASTERSHIP

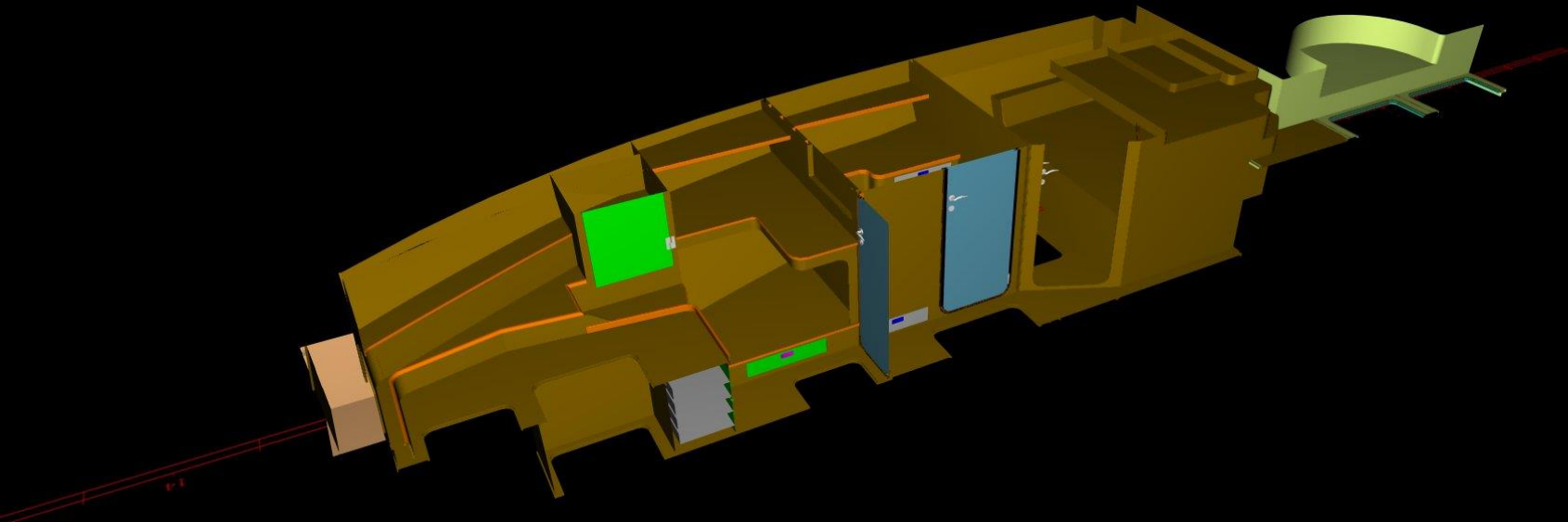

Detailed interior design

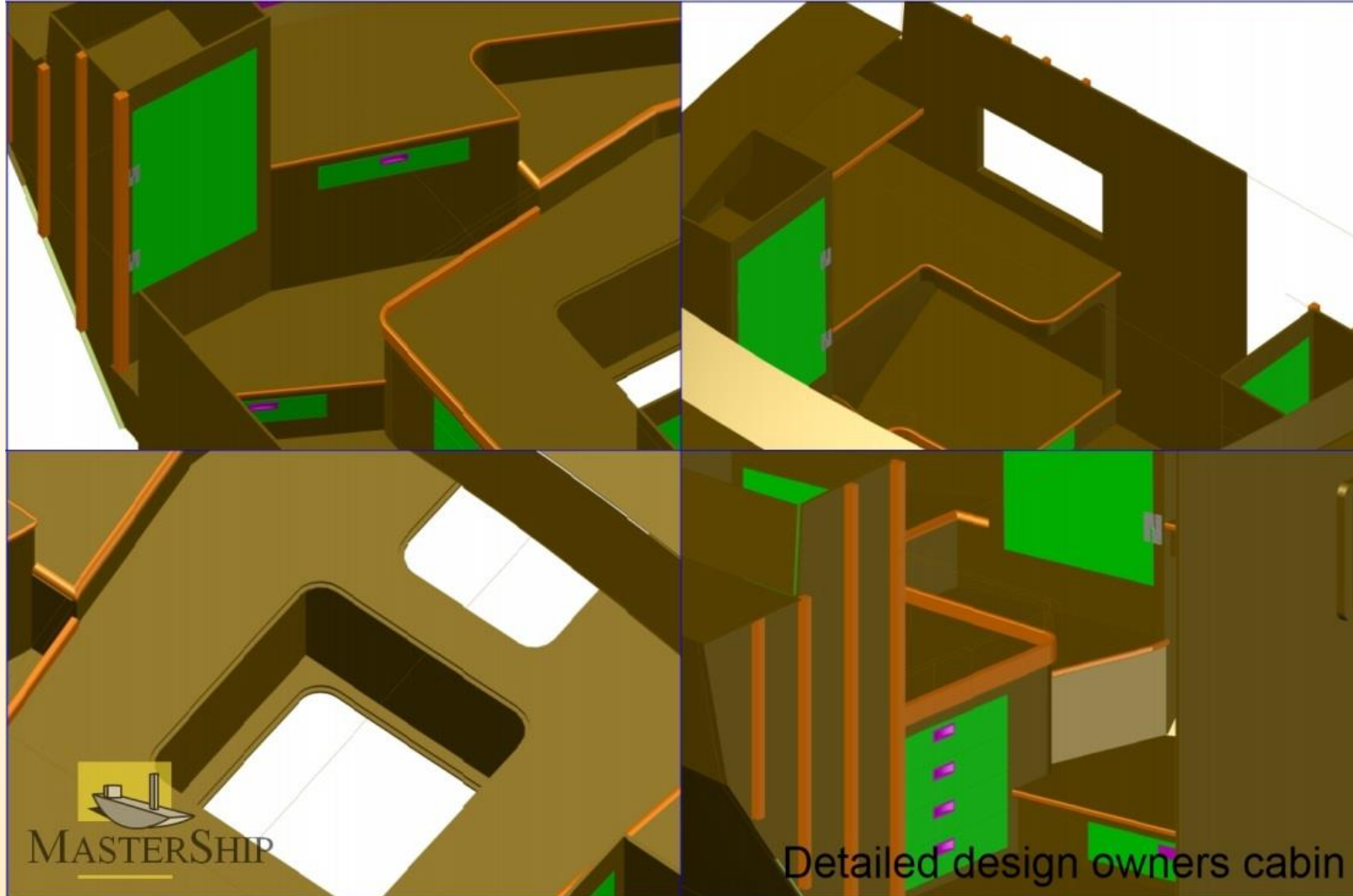

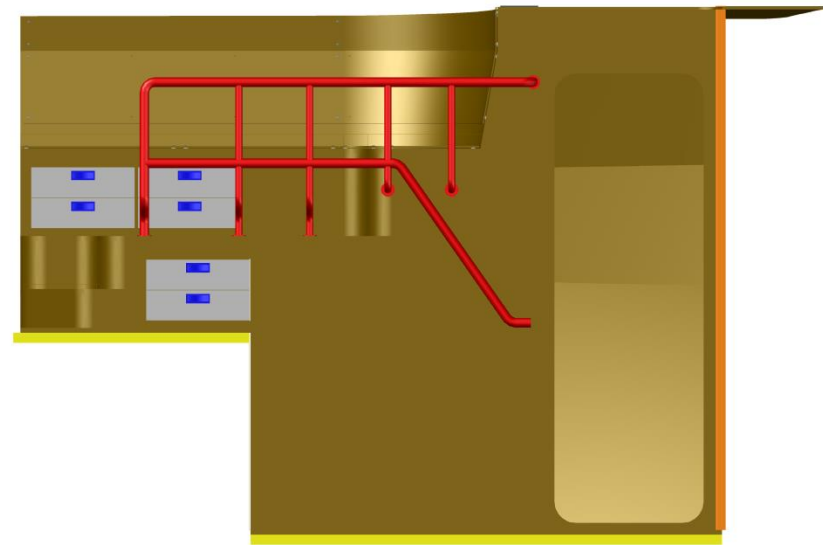
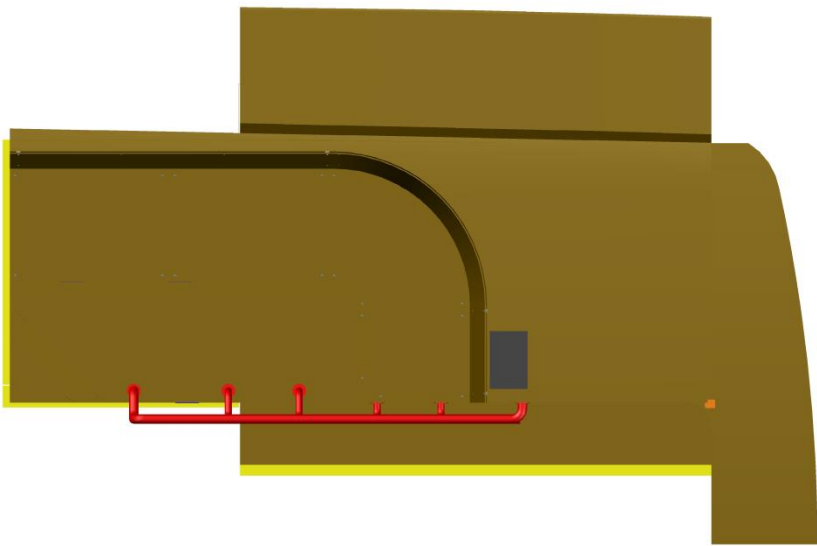
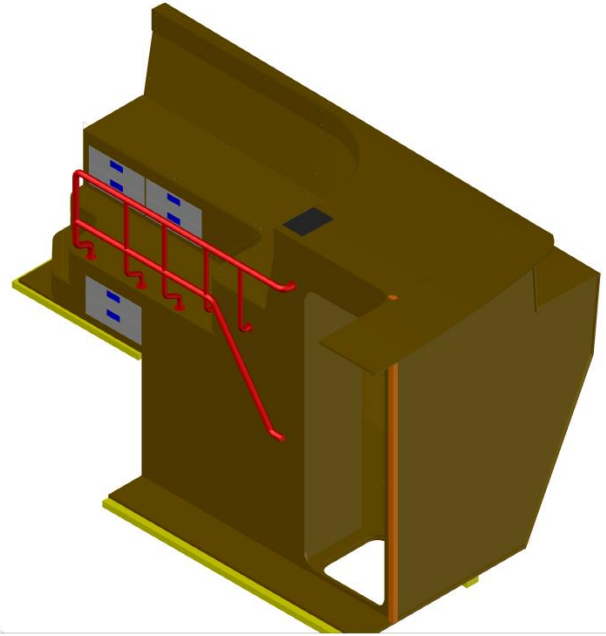
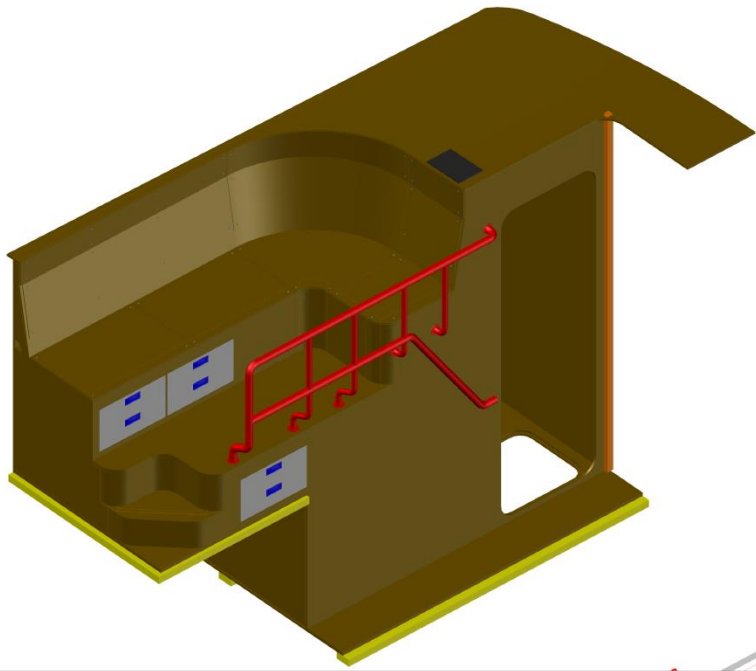



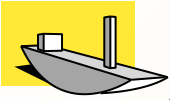

MASTERSHIP

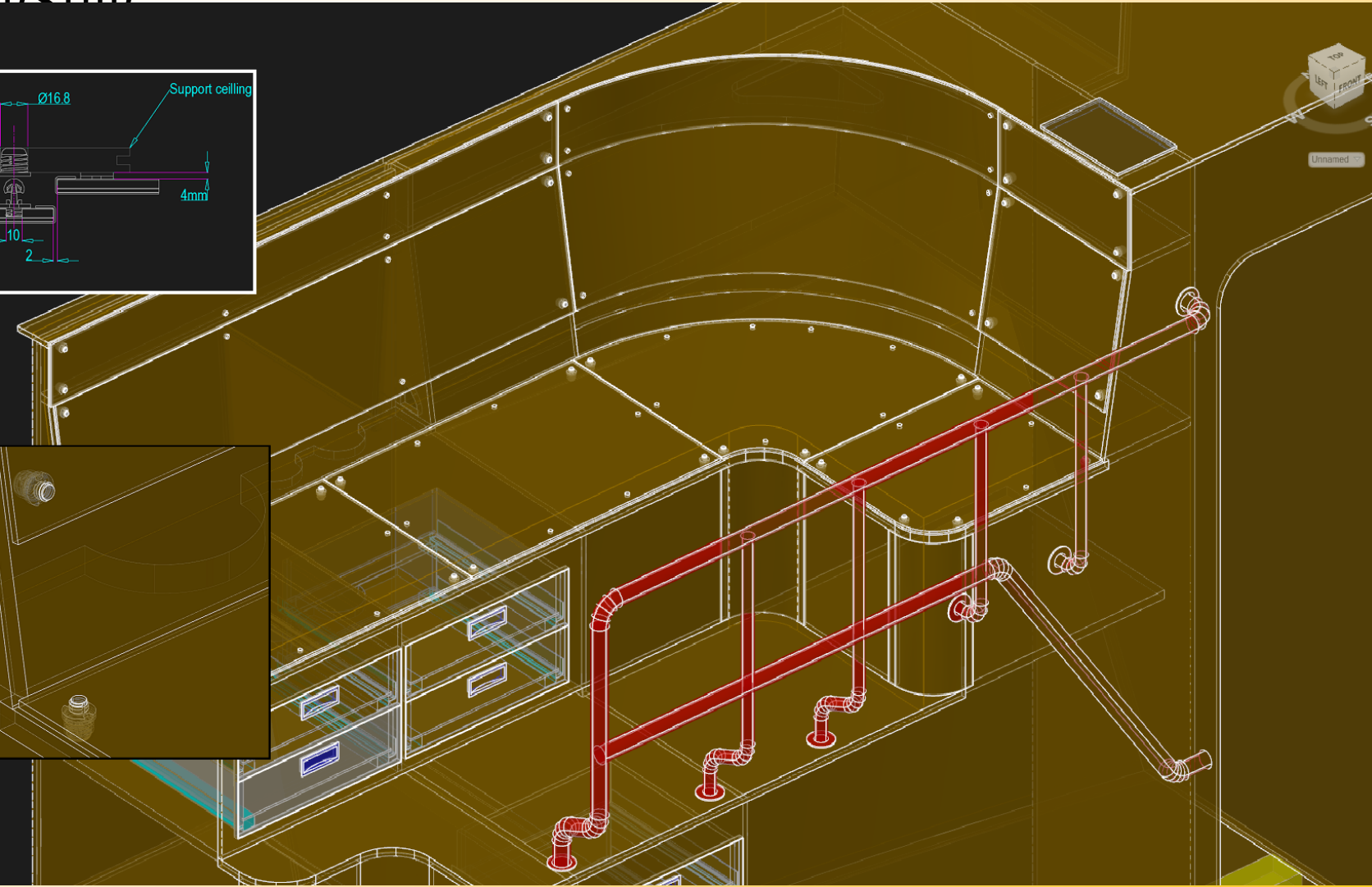
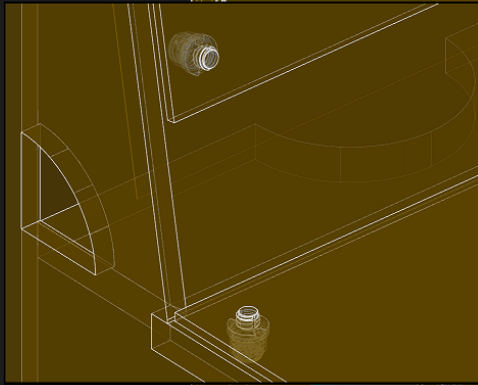
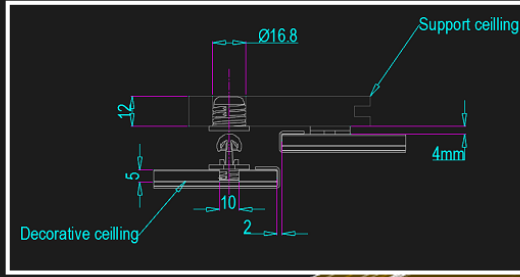





MAST

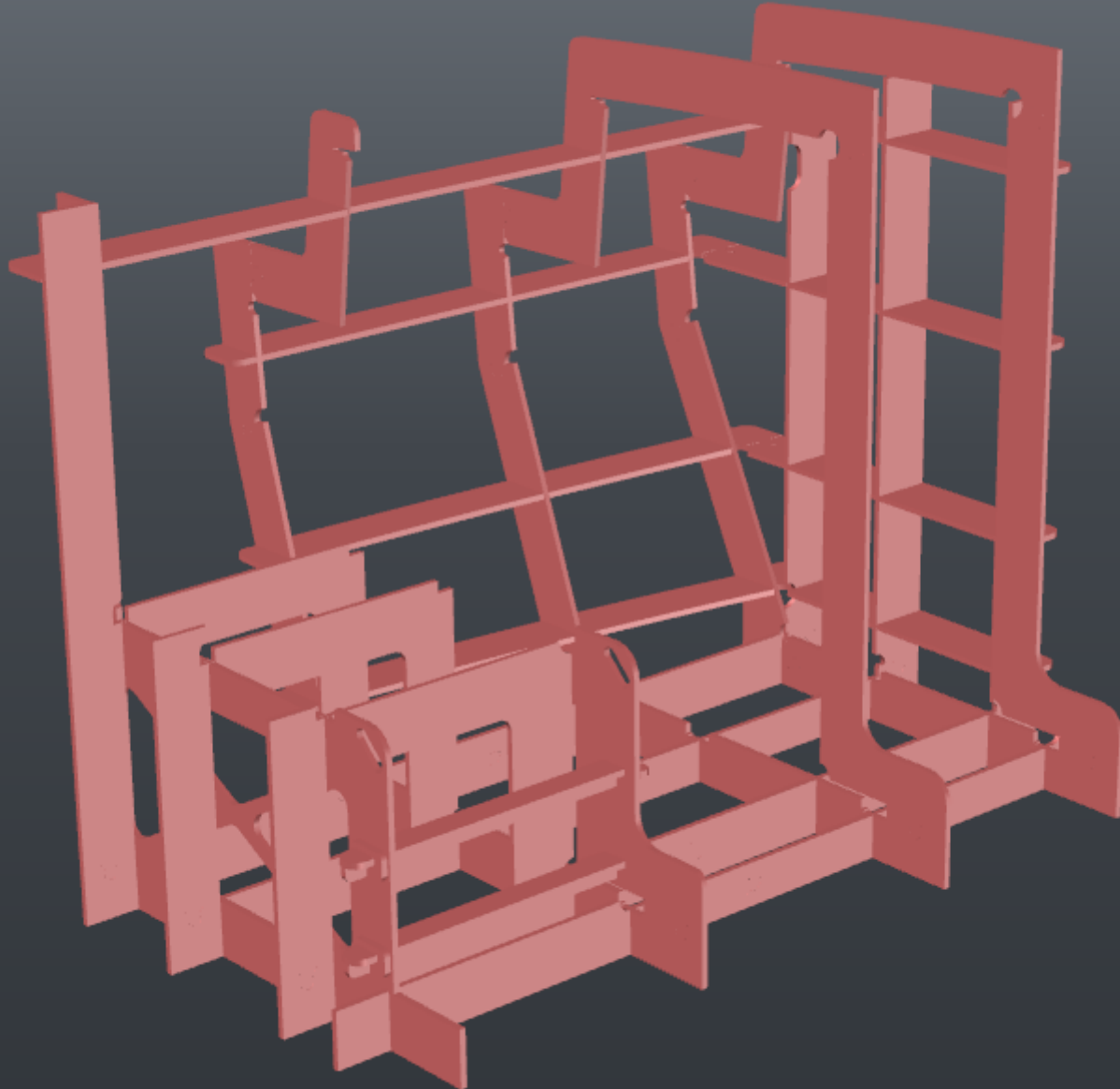

M

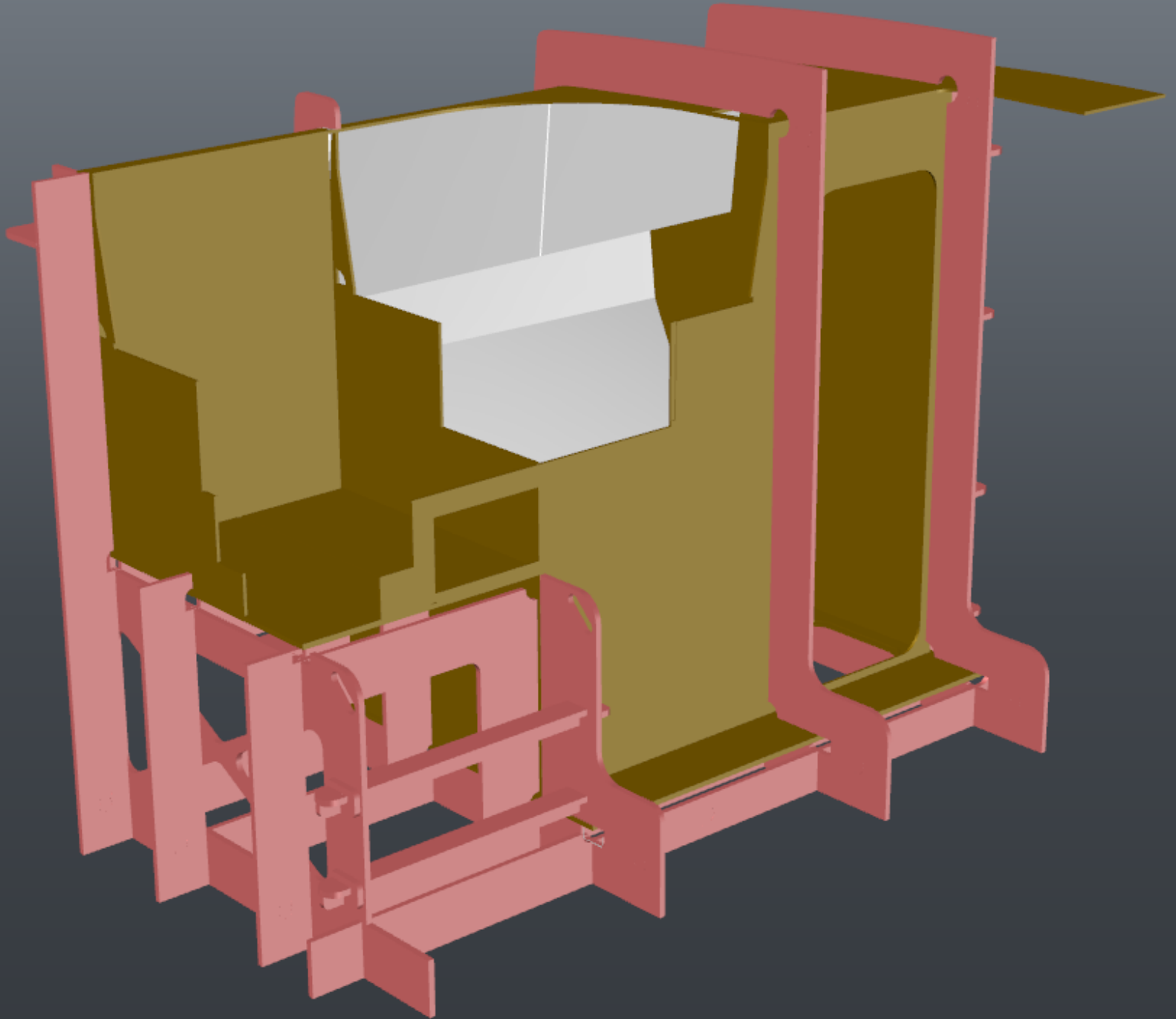

MA

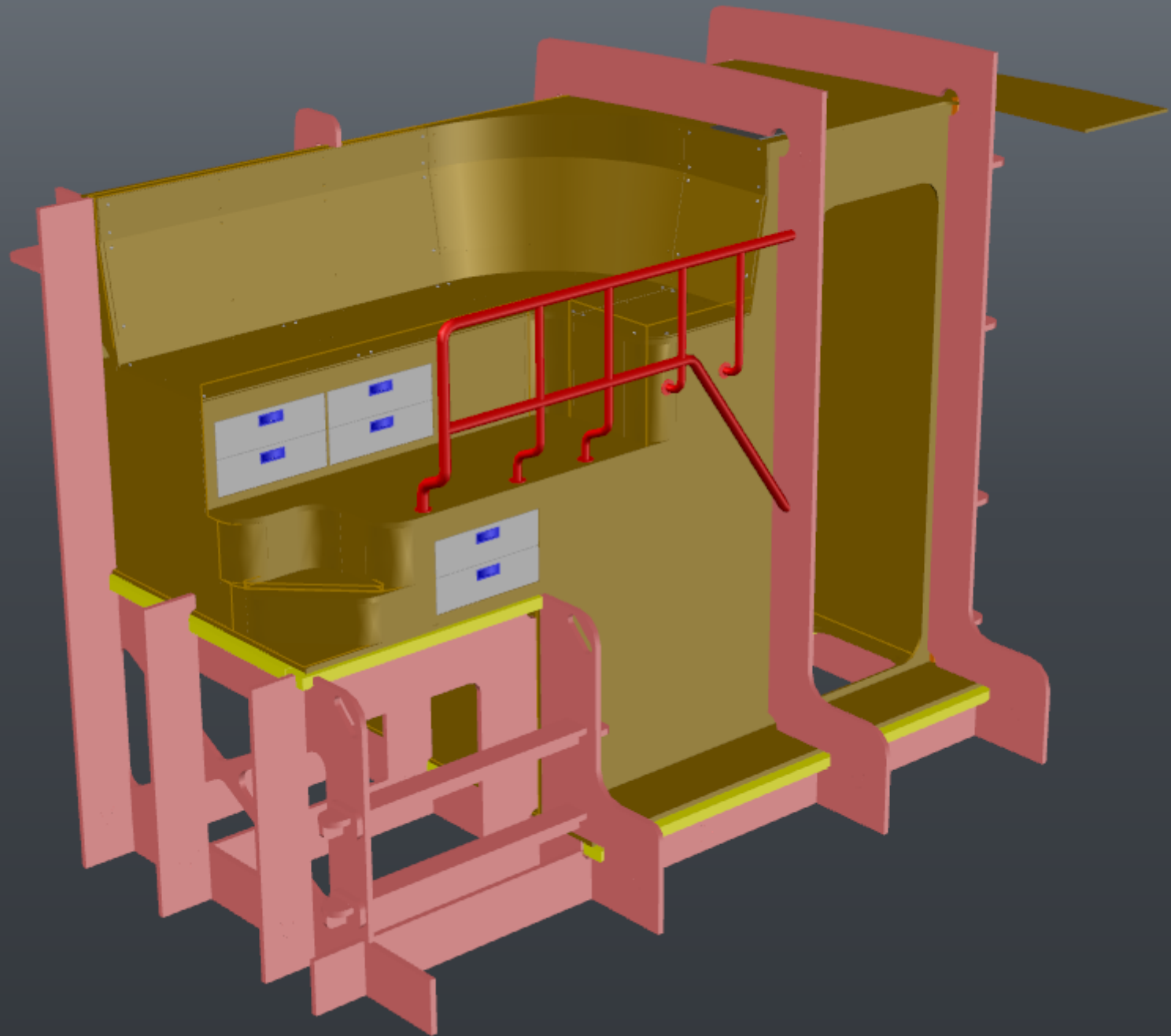

Production interior design

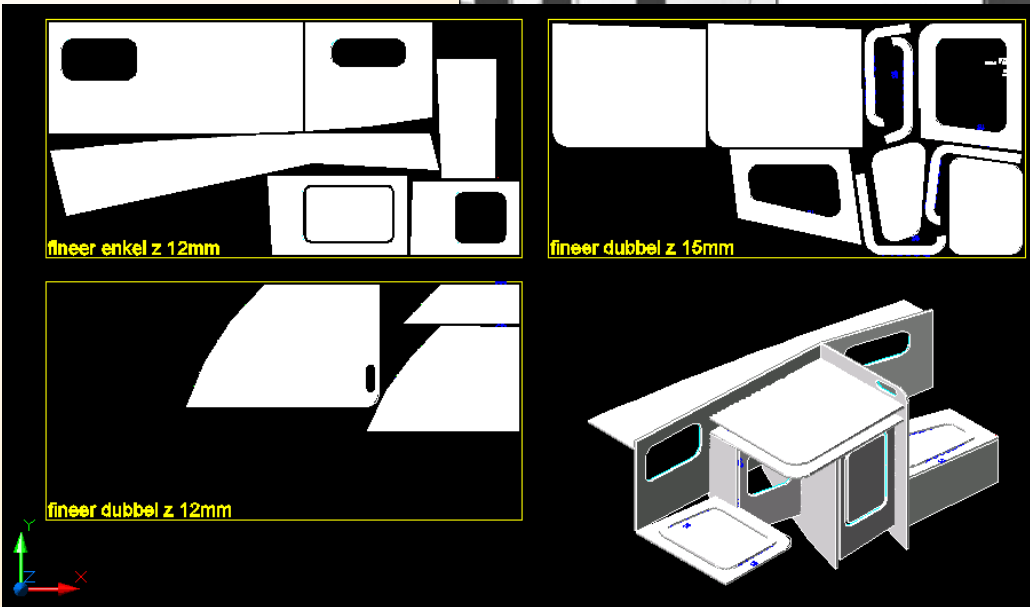
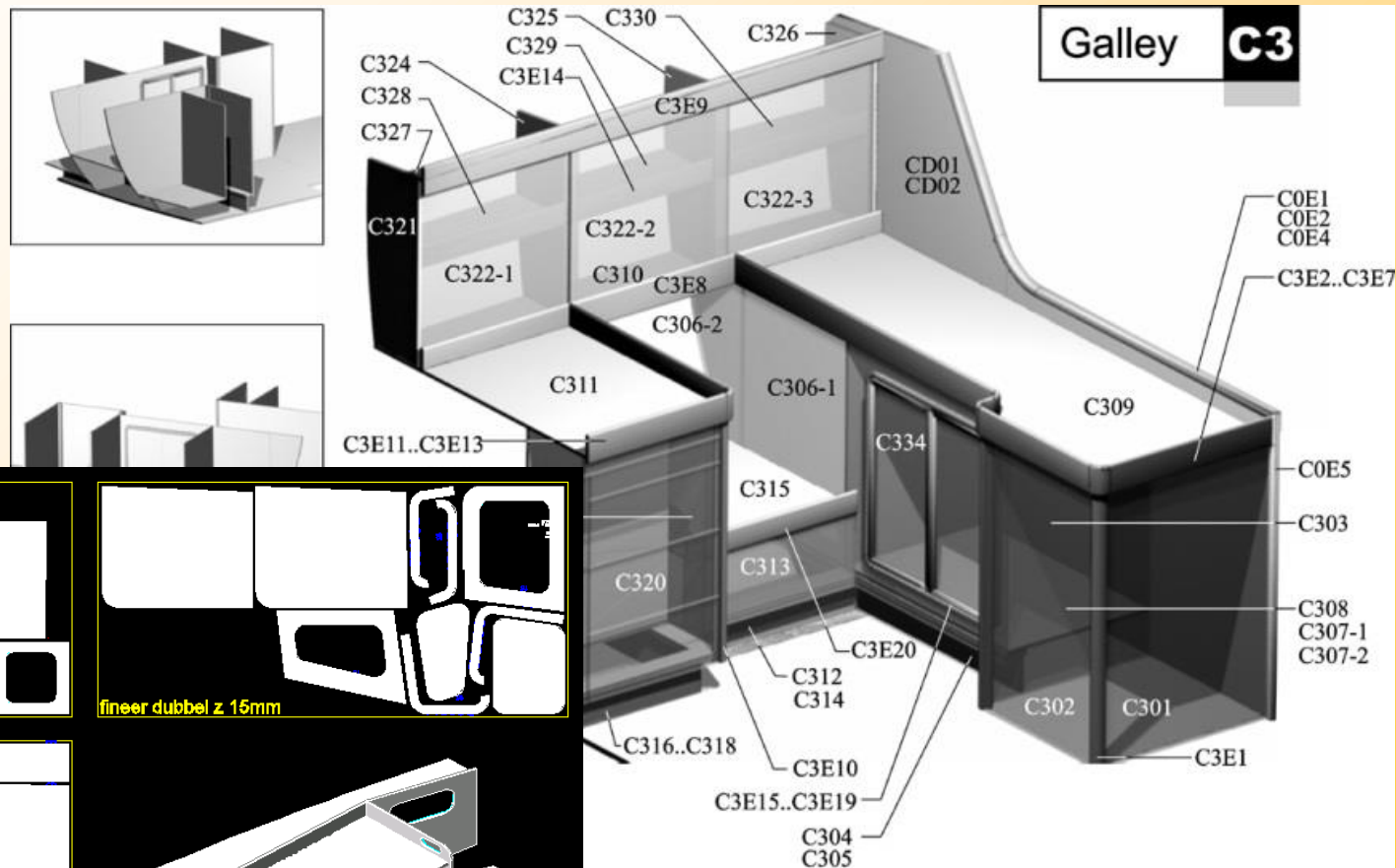

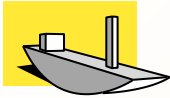

MASTERSHIP

THANKS